

---

**AKUSTIK  
BAFFLE**



# Feltbi Akustik: Akustik Konforda Sürdürülebilir Çözümler

Feltbi Akustik, akustik problemlerinize çözüm sunarken, aynı zamanda sürdürülebilir bir geleceğe katkıda bulunmaya da önem veren bir firmadır. Bunu başarmak için, pet şişeleri geri dönüştürerek akustik ürünler üretmekteyiz.

## Pet şişeleri geri dönüştürmenin birçok faydası vardır:

- Çevreye olan etkimizi azaltır. Pet şişeler, doğada yüzlerce yıl boyunca bozulmadan kalabilen plastik ürünlerdir. Geri dönüştürülerek akustik ürünlere dönüştürülmeleri, bu plastiklerin doğaya zarar vermesini önler.
- Geri dönüşüm oranını artırır. Türkiye’de geri dönüşüm oranı maalesef hala çok düşük. Pet şişeleri geri dönüştürerek, bu oranın artmasına katkıda bulunabiliriz.
- Atık miktarını azaltır. Her gün milyonlarca pet şişe kullanılıyor ve atılıyor. Geri dönüştürülerek, bu atıkların miktarını azaltmak mümkün.
- Doğal kaynaklarımızı korur. Pet şişelerin üretimi için petrol gibi doğal kaynaklar kullanılıyor. Geri dönüştürülerek, bu kaynakların korunmasına katkıda bulunabiliriz.

## Sürdürülebilirlik ilkelerine bağlılığımızın bir göstergesi olarak:

- Üretim süreçlerimizde en son teknolojiyi kullanıyoruz. Bu sayede, enerji ve su kaynaklarını verimli bir şekilde kullanabiliyoruz.
- Geri dönüştürülebilir ürünler üretiyoruz. Ürünlerimiz, kullanılamaz hale geldiğinde tekrar geri dönüştürülebilir.
- Çevre dostu hammaddeler kullanıyoruz. Ürünlerimizde, insan ve çevre sağlığına zarar vermeyen hammaddeler kullanıyoruz.
- Üretim aşamasındayken enerjisiyle kendi elektriğimizi üretiyoruz. Böylelikle bu süreçte fosil yakıtlara olan bağımlılığımızı azaltıyor ve karbon emisyonlarımızı düşürüyoruz.

## Feltbi Akustik ile:

## Sürdürülebilir bir gelecek için Feltbi Akustik’i seçin!

## Plastik Nerede Olmamalı

Her yıl yaklaşık 10 milyon ton plastik atık okyanuslarımıza giriyor ve tüm okyanus kirliliğinin %80’ini oluşturuyor.

## “Tek Kullanımlık Plastiği” Kalıcı Güzelliğe Dönüştürmek

Kullanılmış su şişelerini elyaflara dönüştürerek ses emici yarı sert keçe, sert keçe ürünlerimizi sizlere sunuyoruz.

Feltbi akustik ürünler, hem estetik hem de fonksiyonel açıdan mekanlarınızı güzelleştirmenin yanı sıra, sağlığınız için de önemli faydalar sunar. Ürünlerimiz, REACH, RoHS ve OEKO-TEX gibi uluslararası standartlara uygun olarak üretilmektedir. Bu belgeler, ürünlerin insan sağlığı ve çevre için güvenli olduğunu teyit eder.

**REACH:** Kanserojen olmadığına dahil belgedir.

**RoHS:** Elektrik iletmediğine dahil belgedir.

**OEKO-TEX:** Bebek kıyafetlerinde olan tekstil özelliğine sahip olduğunun belgesidir.

**Yangın Tepki Sınıfı:** Ürünlerimiz Bs1d0 yangın sınıfına sahiptir. Zor alevlenir, alev yürütmez, damlama yapmaz ve zehirli gaz saçmaz.



## FeltBi Akustik Çözümler



Akustik Baffle



Akustik Kanopi



Akustik T24 Asma Tavan Panelleri



Akustik Tavan Panelleri



Akustik Tavan Kaplamaları



Akustik Aydınlatma



Akustik Duvar Panelleri

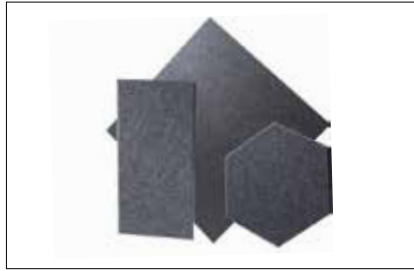

Akustik GEO Parçalar



Akustik GEO Duvar Panelleri



Akustik Duvar Kaplamaları



Akustik 3D Duvar Kaplamaları



Akustik Ses Yalıtımlı Perde



Akustik Keçe Perde



Akustik Separatör



Akustik Masa Bölücüler



## Akustik Baffle

FeltBi Baffle ürünleri, tavana zarif bir şekilde asılırlar. En yüksek kalitede ses emilimini sağlayan , projenize göre özelleştirilebilen, dilediğiniz ölçü ve kalınlıkta, istediğiniz renkte üretilmektedir. Akustik Baffle ürünlerimizi yapmak için Polyester Elyaf (PET) Keçe kullanıyoruz. PET Keçe, mükemmel akustik performans ve dayanıklılık gösteren yumuşak ama güçlü bir malzemedir. Sağlıklıdır, kokusuzdur. Küf tutmaz. Yanıcı malzeme değildir. Bakımı kolaydır, ömrü uzundur. Bu nedenle çok uzun süre kullanma özelliğine sahiptir. Tavana gerekli sayıda askı çubukları ile asılır. Yüksekliği istediğiniz gibi ayarlayabilirsiniz. Feltbi Keçe baffle ürünler mimar ve tasarımcıların estetik vizyonuna uygun olarak çeşitli şekil ve renklerde tasarlanır. Değişik ve fonksiyonel mekanlar yaratılmasına yardımcı olur.

Tasarım ve proje ekibimiz proje bitimine kadar sizinle birlikte çalışacak, teslimat ve kurulum ve sonrası içinde sizlere destek vermeye devam edecektir.

FeltBi Akustik Baffle ürünlerinin yüksek ses emilimi özelliği ile Mekanlar Şimdi Çok Akustik!



# Baffle Panel Teknik Özellikleri

FeltBi Polyester Elyaf Keçe  
1. Katman - Renk ve Doku

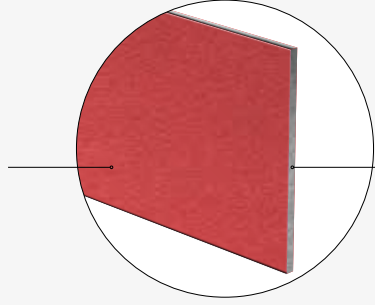

FeltBi Sert Keçe  
Temel Katman - Akustik özellik

## Keçe Panel Katman Kaplama Çeşitleri

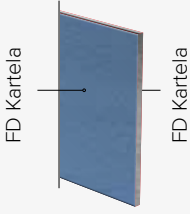

Bakınız sayfa 27

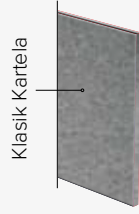

Bakınız sayfa 30

Daha fazla renk seçeneğine ihtiyacınız varsa ve özgün bir tasarım oluşturmak istiyorsanız, FD kartela sizin için daha iyi bir seçim olabilir.

Daha sade ve minimalist bir görünüm istiyorsanız veya renklerin birbiriyle uyumundan emin olmak istiyorsanız, klasik kartela sizin için daha iyi bir seçim olabilir.

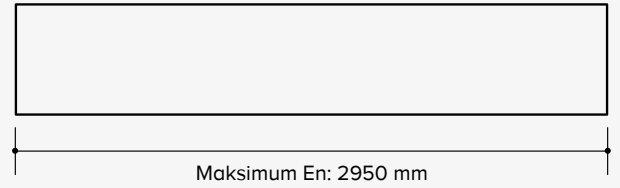
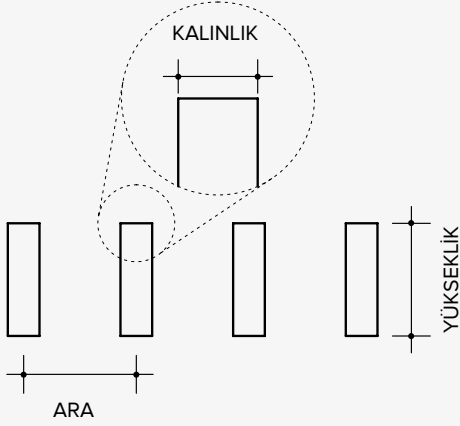

Kalınlık (mm)	Yükseklik (mm)	Ara (mm)	Uzunluk (mm)
12	100	100	2950 maksimum
15	150	150	
20	200	200	
30	250	250	
40	400		
50	500		
	600		

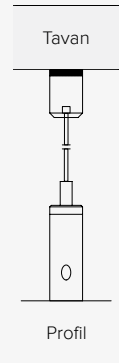

Çelik telli asansörlü  
tavan askı aparatı

## Akustik Düz Baffle Modeller



**BFL-D01**  
Sayfa. 08



**BFL-D02**  
Sayfa. 10



**BFL-D03**  
Sayfa. 12



**BFL-D04**  
Sayfa. 14



**BFL-D05**  
Sayfa. 16



**BFL-D06**  
Sayfa. 18



**BFL-D07**  
Sayfa. 20



**BFL-D08**  
Sayfa. 22

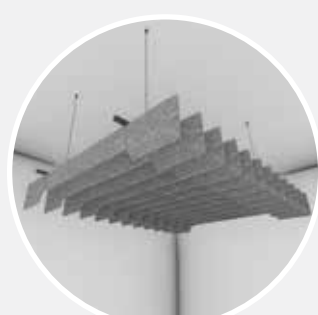

**BFL-D09**  
Sayfa. 24



**BFL-D10**  
Sayfa. 26



**BFL-D11**  
Sayfa. 28



**BFL-D12**  
Sayfa. 30

**Akustik Baffles - BFL-D01**



**Akustik Baffles - BFL-D02**

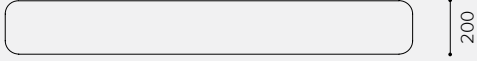

**Akustik Baffles - BFL-D03**

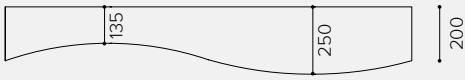
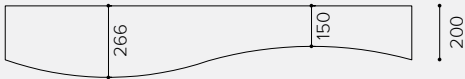

**Akustik Baffles - BFL-D04**

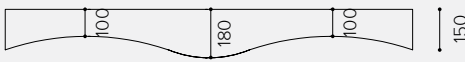

**Akustik Baffles - BFL-D05**

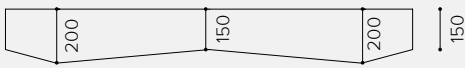

**Akustik Baffles - BFL-D06**

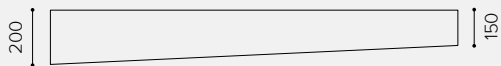
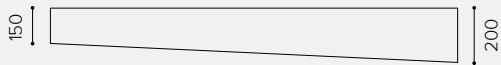

**Akustik Baffles - BFL-D07**

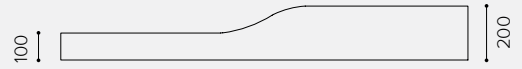
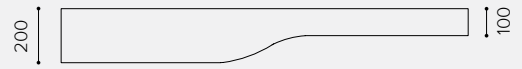

**Akustik Baffles - BFL-D08**

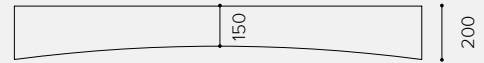

**Akustik Baffles - BFL-D09**

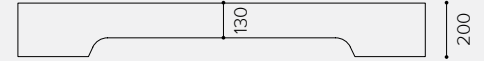

**Akustik Baffles - BFL-D10**

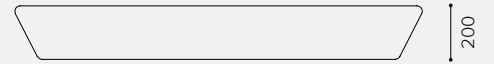

**Akustik Baffles - BFL-D11**

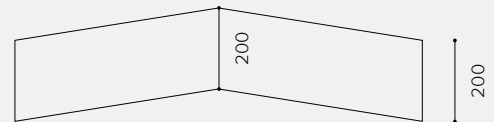

**Akustik Baffles - BFL-D12**

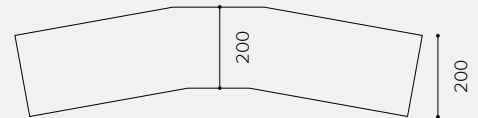

## FeltBi Düz Baffle | BFL-D01

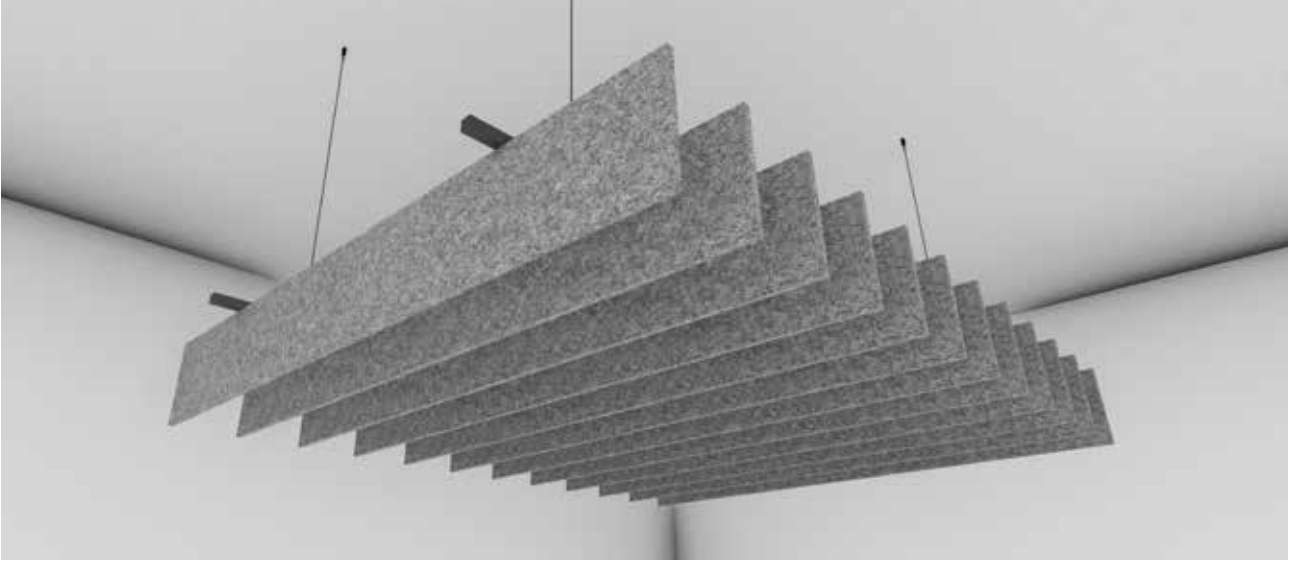

### Özellikler

<b>Malzeme:</b>	Polyester Elyaf Keçe
<b>Akustik özellikler:</b>	NRC: 0,40-0,90
<b>Yangın sınıfı:</b>	B-s1, d0
<b>Renk:</b>	FD Kartela (Bakınız sayfa 27), Klasik Kartela (Bakınız sayfa 30,) KD Kartela (Bakınız sayfa 30)
<b>Kurulum:</b>	Çelik telli asansörlü tavan askı aparatı
<b>Bakım:</b>	Elektrik süpürgesi ile düşük devirde ağır baskı uygulanmadan dış yüzey temizliği yapılabilir. Nemli bir bezle hafifçe silinerek dış yüzey temizliği yapılabilir.

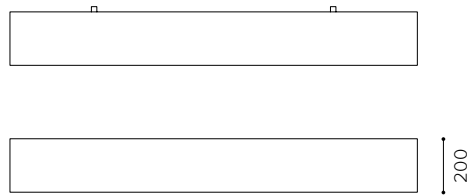
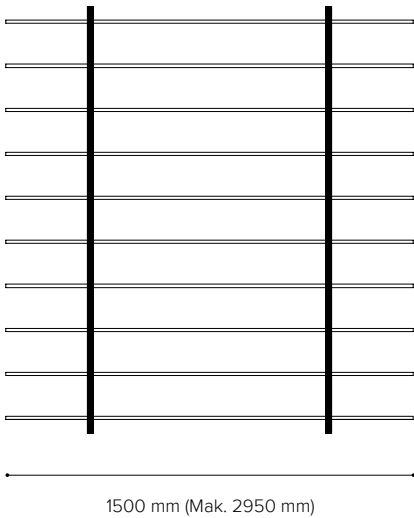

Kalınlık (mm)	Yükseklik (mm)	Ara (mm)
12	100	100
15	150	150
20	200	200
30	250	250
40	400	400
50	500	500
	600	600

# FeltBi Düz Baffle | BFL-D02

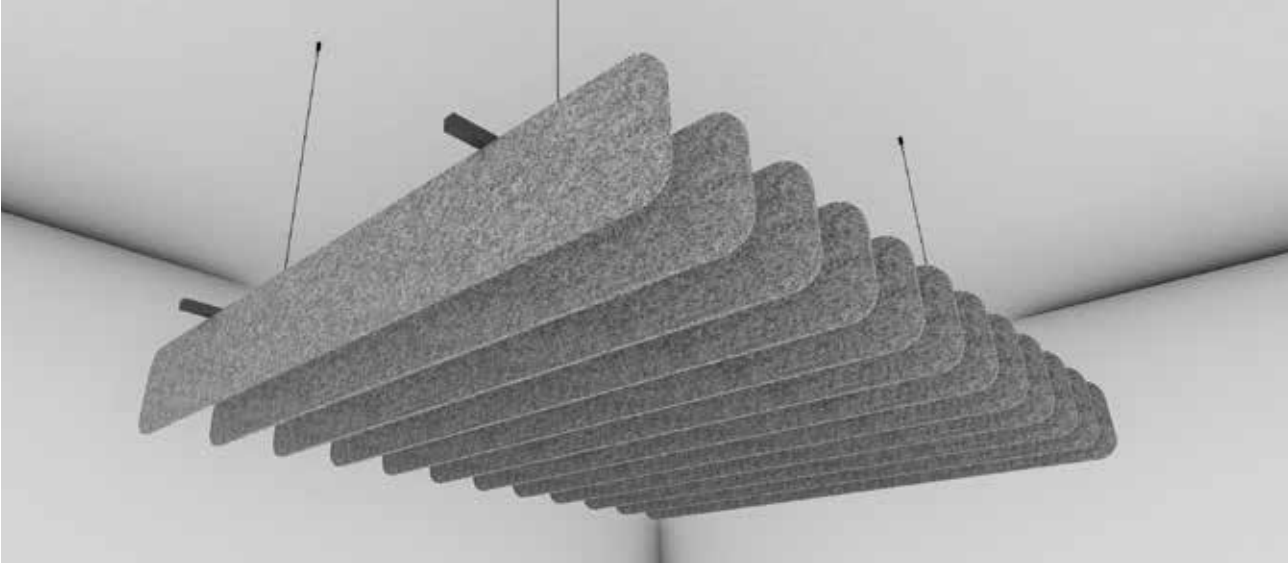

## Özellikler

<b>Malzeme:</b>	Polyester Elyaf Keçe
<b>Akustik özellikler:</b>	NRC: 0,40-0,90
<b>Yangın sınıfı:</b>	B-s1, d0
<b>Renk:</b>	FD Kartela (Bakınız sayfa 27), Klasik Kartela (Bakınız sayfa 30,) KD Kartela (Bakınız sayfa 30)
<b>Kurulum:</b>	Çelik telli asansörlü tavan askı aparatı
<b>Bakım:</b>	Elektrik süpürgesi ile düşük devirde ağır baskı uygulanmadan dış yüzey temizliği yapılabilir. Nemli bir bezle hafifçe silinerek dış yüzey temizliği yapılabilir.

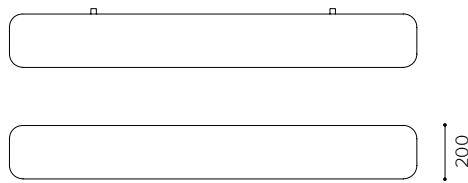
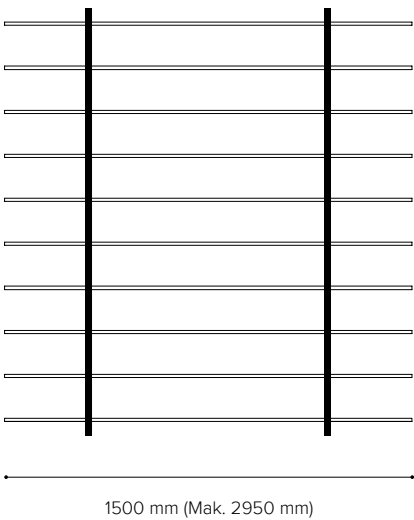

Kalınlık (mm)	Yükseklik (mm)	Ara (mm)
12	100	100
15	150	150
20	200	200
30	250	250
40	400	400
50	500	500
	600	600

## FeltBi Düz Baffle | BFL-D03

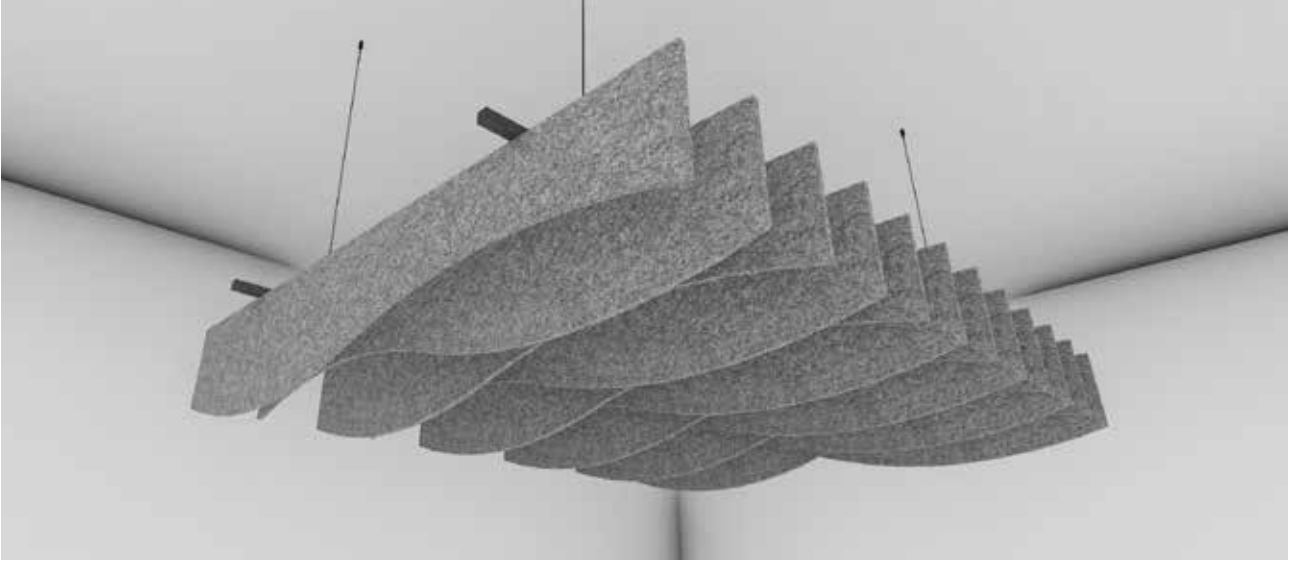

### Özellikler

<b>Malzeme:</b>	Polyester Elyaf Keçe
<b>Akustik özellikler:</b>	NRC: 0,40-0,90
<b>Yangın sınıfı:</b>	B-s1, d0
<b>Renk:</b>	FD Kartela (Bakınız sayfa 27), Klasik Kartela (Bakınız sayfa 30), KD Kartela (Bakınız sayfa 30)
<b>Kurulum:</b>	Çelik telli asansörlü tavan askı aparatı
<b>Bakım:</b>	Elektrik süpürgesi ile düşük devirde ağır baskı uygulanmadan dış yüzey temizliği yapılabilir. Nemli bir bezle hafifçe silinerek dış yüzey temizliği yapılabilir.

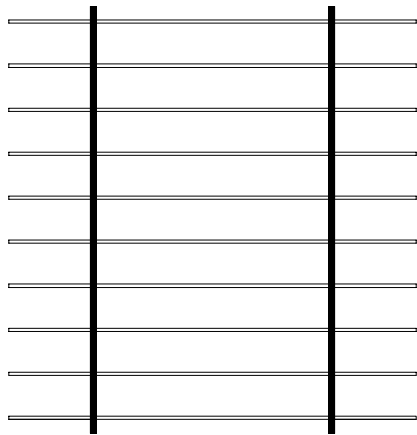

1500 mm (Mak. 2950 mm)

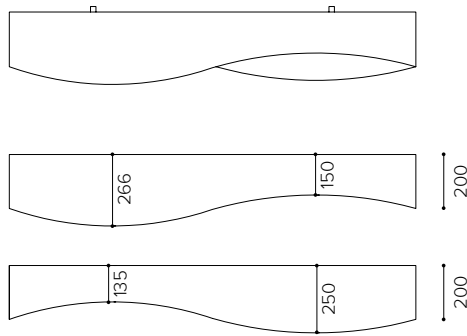

Kalınlık (mm)	Yükseklik (mm)	Ara (mm)
12	100	100
15	150	150
20	200	200
30	250	250
40	400	400
50	500	500
	600	600

Kalınlık

Yükseklik

Ara

# FeltBi Düz Baffle | BFL-D04

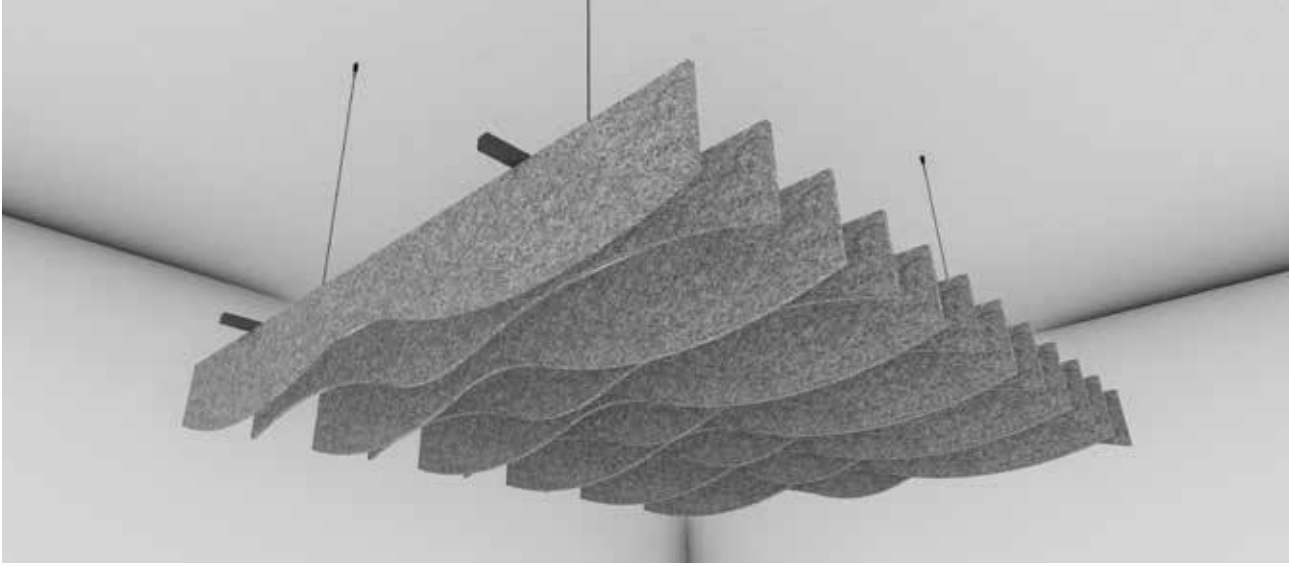

## Özellikler

**Malzeme:** Polyester Elyaf Keçe

**Akustik özellikler:** NRC: 0,40-0,90

**Yangın sınıfı:** B-s1, d0

**Renk:** FD Kartela (Bakınız sayfa 27), Klasik Kartela (Bakınız sayfa 30), KD Kartela (Bakınız sayfa 30)

**Kurulum:** Çelik telli asansörlü tavan askı aparatı

**Bakım:** Elektrik süpürgesi ile düşük devirde ağır baskı uygulanmadan dış yüzey temizliği yapılabilir. Nemli bir bezle hafifçe silinerek dış yüzey temizliği yapılabilir.

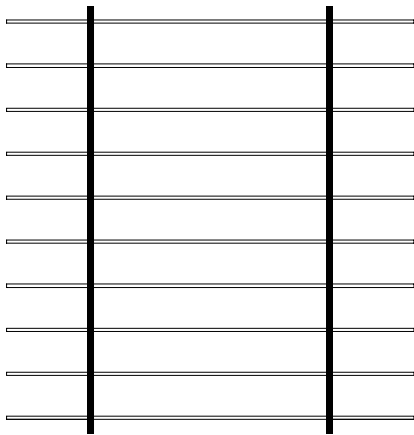

1500 mm (Mak. 2950 mm)

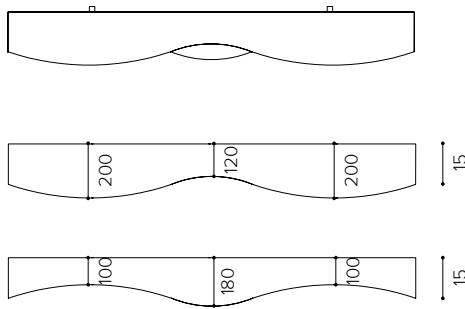

Kalınlık (mm)	Yükseklik (mm)	Ara (mm)
12	100	100
15	150	150
20	200	200
30	250	250
40	400	400
50	500	500
	600	600

## FeltBi Düz Baffle | BFL-D05

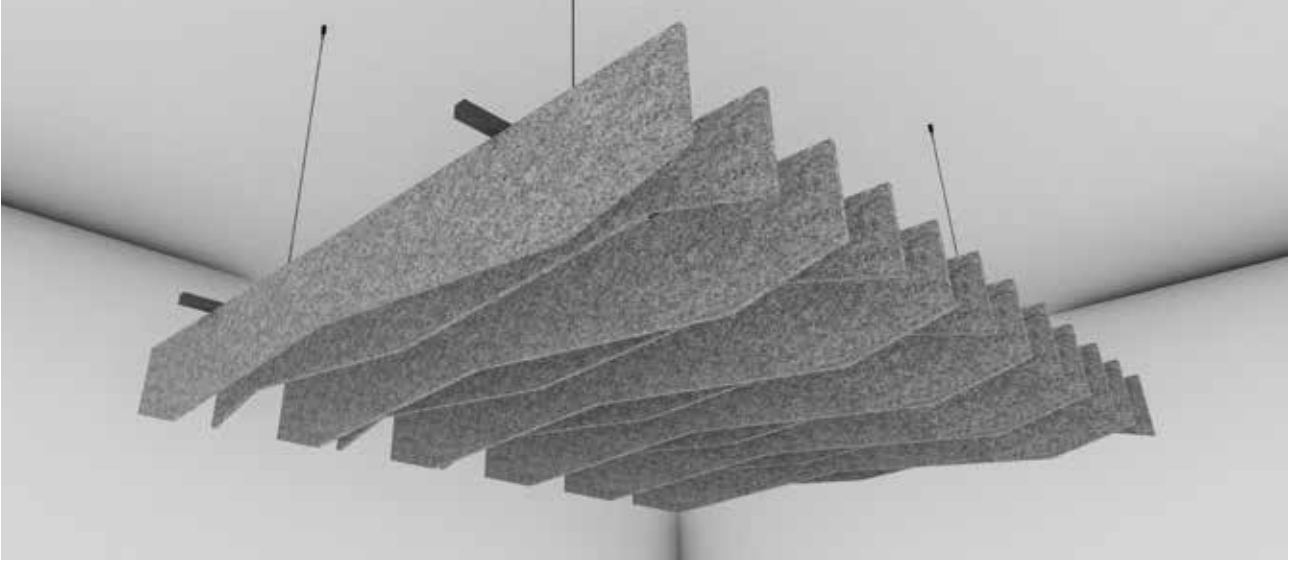

### Özellikler

<b>Malzeme:</b>	Polyester Elyaf Keçe
<b>Akustik özellikler:</b>	NRC: 0,40-0,90
<b>Yangın sınıfı:</b>	B-s1, d0
<b>Renk:</b>	FD Kartela (Bakınız sayfa 27), Klasik Kartela (Bakınız sayfa 30), KD Kartela (Bakınız sayfa 30)
<b>Kurulum:</b>	Çelik telli asansörlü tavan askı aparatı
<b>Bakım:</b>	Elektrik süpürgesi ile düşük devirde ağır baskı uygulanmadan dış yüzey temizliği yapılabilir. Nemli bir bezle hafifçe silinerek dış yüzey temizliği yapılabilir.

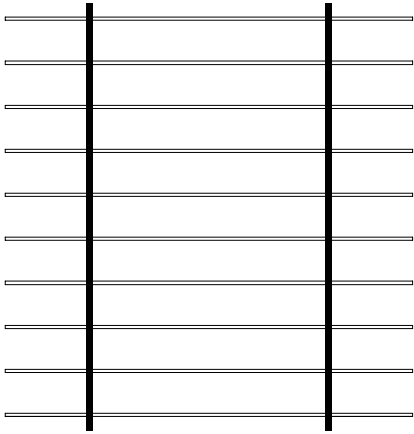

1500 mm (Mak. 2950 mm)

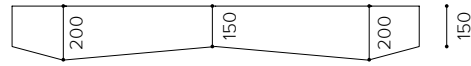

Kalınlık (mm)	Yükseklik (mm)	Ara (mm)
12	100	100
15	150	150
20	200	200
30	250	250
40	400	400
50	500	500
	600	600

Kalınlık

Yükseklik

Ara

# FeltBi Düz Baffle | BFL-D06

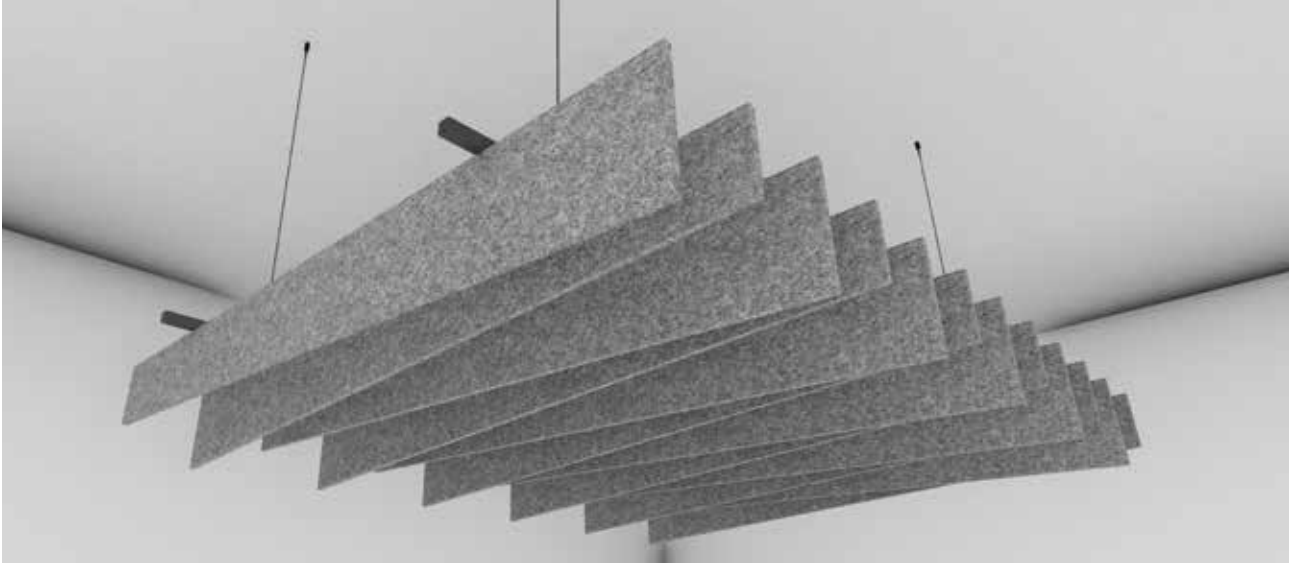

## Özellikler

**Malzeme:** Polyester Elyaf Keçe

**Akustik özellikler:** NRC: 0,40-0,90

**Yangın sınıfı:** B-s1, d0

**Renk:** FD Kartela (Bakınız sayfa 27), Klasik Kartela (Bakınız sayfa 30), KD Kartela (Bakınız sayfa 30)

**Kurulum:** Çelik telli asansörlü tavan askı aparatı

**Bakım:** Elektrik süpürgesi ile düşük devirde ağır baskı uygulanmadan dış yüzey temizliği yapılabilir. Nemli bir bezle hafifçe silinerek dış yüzey temizliği yapılabilir.

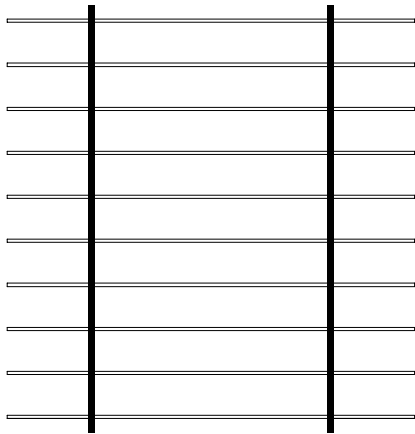

1500 mm (Mak. 2950 mm)

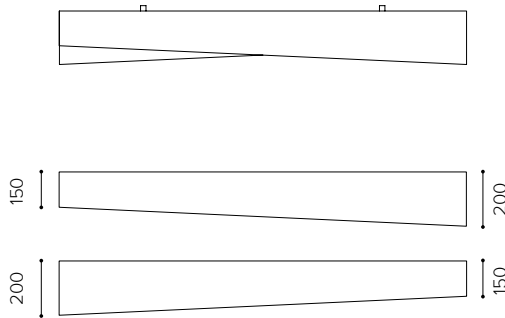

Kalınlık (mm)	Yükseklik (mm)	Ara (mm)
12	100	100
15	150	150
20	200	200
30	250	250
40	400	400
50	500	500
	600	600

## FeltBi Düz Baffle | BFL-D07

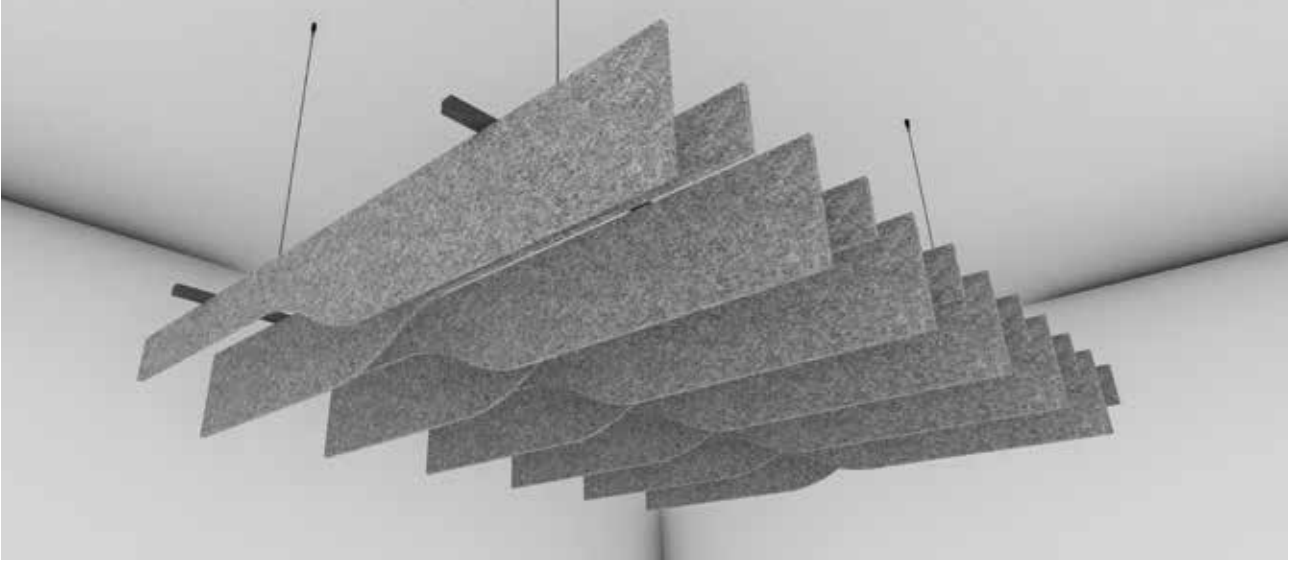

### Özellikler

<b>Malzeme:</b>	Polyester Elyaf Keçe
<b>Akustik özellikler:</b>	NRC: 0,40-0,90
<b>Yangın sınıfı:</b>	B-s1, d0
<b>Renk:</b>	FD Kartela (Bakınız sayfa 27), Klasik Kartela (Bakınız sayfa 30), KD Kartela (Bakınız sayfa 30)
<b>Kurulum:</b>	Çelik telli asansörlü tavan askı aparatı
<b>Bakım:</b>	Elektrik süpürgesi ile düşük devirde ağır baskı uygulanmadan dış yüzey temizliği yapılabilir. Nemli bir bezle hafifçe silinerek dış yüzey temizliği yapılabilir.

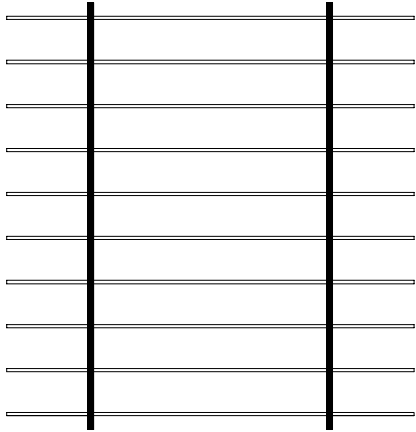

1500 mm (Mak. 2950 mm)

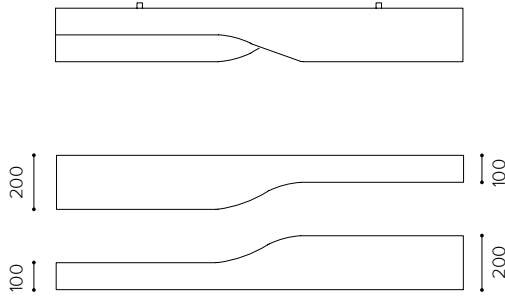

Kalınlık (mm)	Yükseklik (mm)	Ara (mm)
12	100	100
15	150	150
20	200	200
30	250	250
40	400	400
50	500	500
	600	600

Kalınlık

Ara

Yükseklik

# FeltBi Düz Baffle | BFL-D08

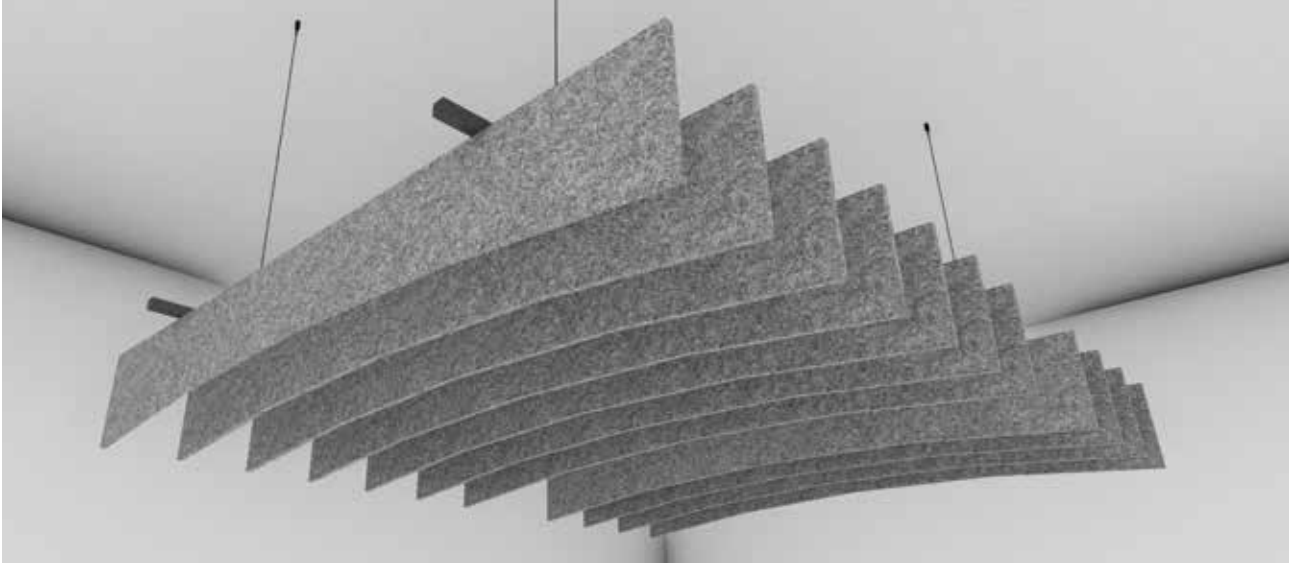

## Özellikler

**Malzeme:** Polyester Elyaf Keçe

**Akustik özellikler:** NRC: 0,40-0,90

**Yangın sınıfı:** B-s1, d0

**Renk:** FD Kartela (Bakınız sayfa 27), Klasik Kartela (Bakınız sayfa 30), KD Kartela (Bakınız sayfa 30)

**Kurulum:** Çelik telli asansörlü tavan askı aparatı

**Bakım:** Elektrik süpürgesi ile düşük devirde ağır baskı uygulanmadan dış yüzey temizliği yapılabilir.  
Nemli bir bezle hafifçe silinerek dış yüzey temizliği yapılabilir.

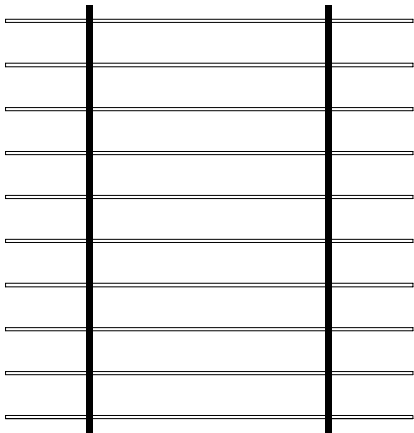

1500 mm (Mak. 2950 mm)

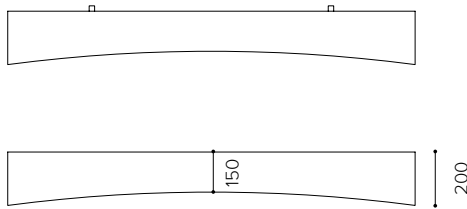

Kalınlık (mm)	Yükseklik (mm)	Ara (mm)
12	100	100
15	150	150
20	200	200
30	250	250
40	400	400
50	500	500
	600	600

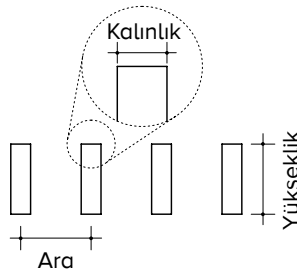

## FeltBi Düz Baffle | BFL-D09

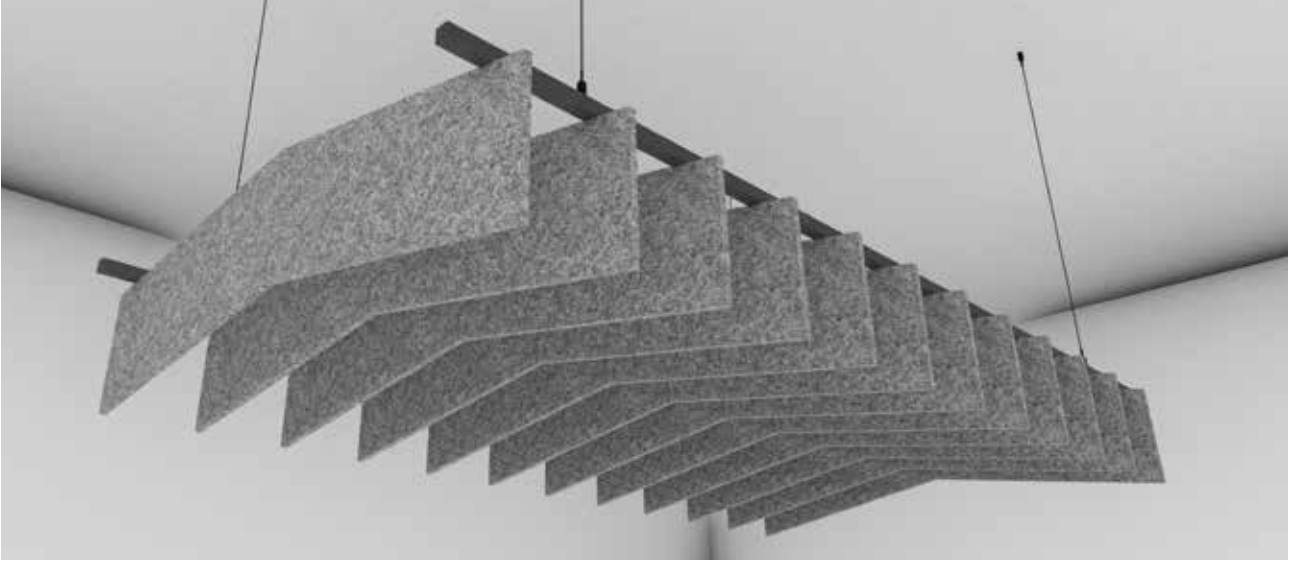

### Özellikler

**Malzeme:** Polyester Elyaf Keçe

**Akustik özellikler:** NRC: 0,40-0,90

**Yangın sınıfı:** B-s1, d0

**Renk:** FD Kartela (Bakınız sayfa 27), Klasik Kartela (Bakınız sayfa 30), KD Kartela (Bakınız sayfa 30)

**Kurulum:** Çelik telli asansörlü tavan askı aparatı

**Bakım:** Elektrik süpürgesi ile düşük devirde ağır baskı uygulanmadan dış yüzey temizliği yapılabilir.  
Nemli bir bezle hafifçe silinerek dış yüzey temizliği yapılabilir.

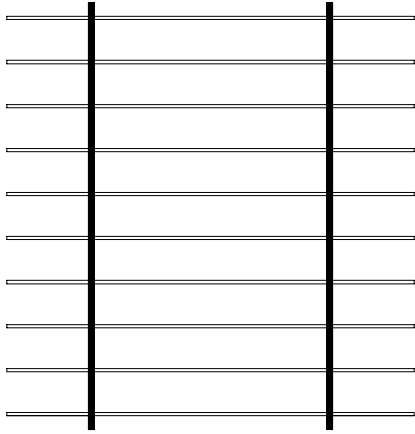

1000 mm (Mak. 2950 mm)

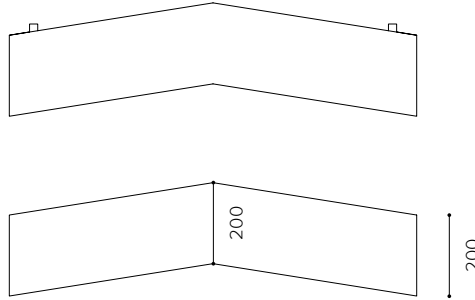

Kalınlık (mm)	Yükseklik (mm)	Ara (mm)
12	100	100
15	150	150
20	200	200
30	250	250
40	400	400
50	500	500
	600	600

The table is accompanied by a diagram showing three rectangular panels of different sizes. The top panel is labeled 'Kalınlık' (Thickness) and the bottom panel is labeled 'Yükseklik' (Height). The spacing between the panels is labeled 'Ara' (Gap).

# FeltBi Düz Baffle | BFL-D10

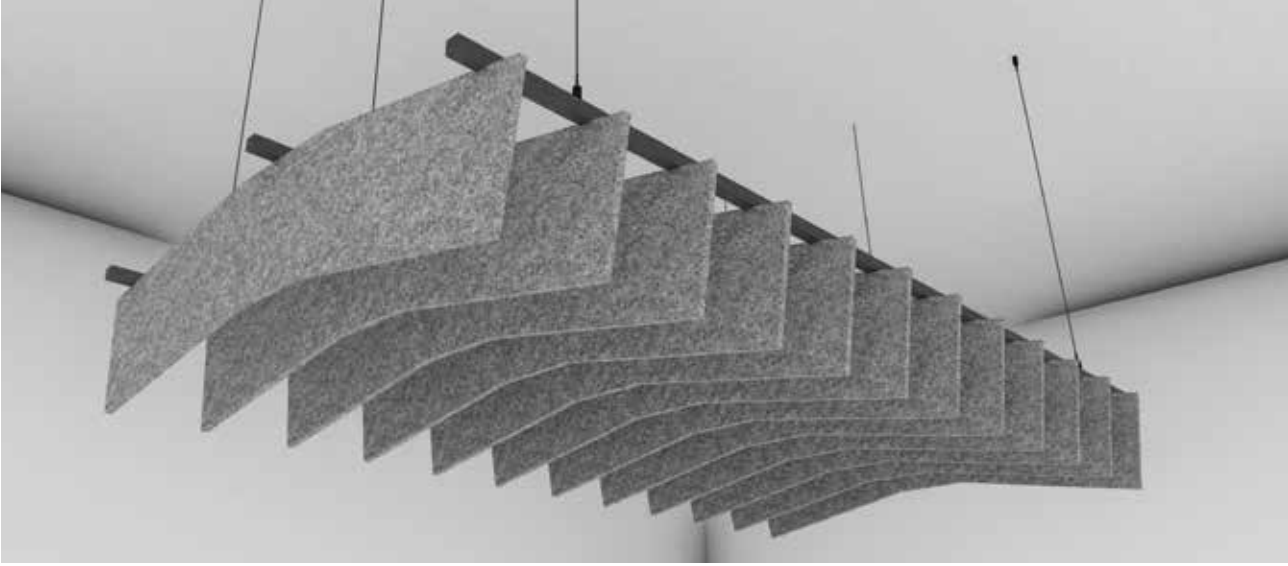

## Özellikler

**Malzeme:** Polyester Elyaf Keçe

**Akustik özellikler:** NRC: 0,40-0,90

**Yangın sınıfı:** B-s1, d0

**Renk:** FD Kartela (Bakınız sayfa 27), Klasik Kartela (Bakınız sayfa 30), KD Kartela (Bakınız sayfa 30)

**Kurulum:** Çelik telli asansörlü tavan askı aparatı

**Bakım:** Elektrik süpürgesi ile düşük devirde ağır baskı uygulanmadan dış yüzey temizliği yapılabilir. Nemli bir bezle hafifçe silinerek dış yüzey temizliği yapılabilir.

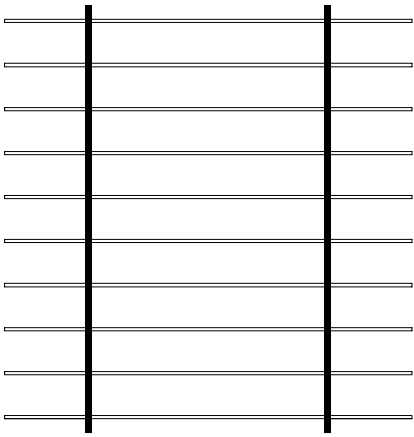

1000 mm (Mak. 2950 mm)

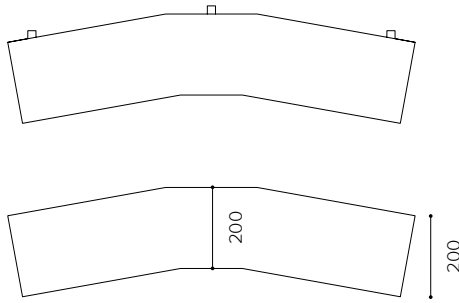

Kalınlık (mm)	Yükseklik (mm)	Ara (mm)
12	100	100
15	150	150
20	200	200
30	250	250
40	400	400
50	500	500
	600	600

## Akustik Panel Baffle Modeller

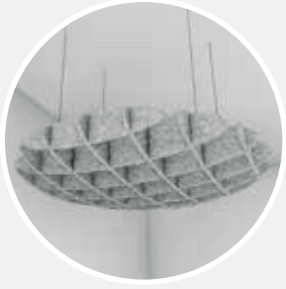

**BFL-P01**  
Sayfa 34



**BFL-P02**  
Sayfa 36

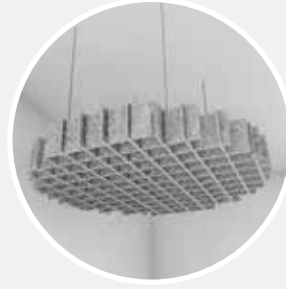

**BFL-P03**  
Sayfa 38



**BFL-P04**  
Sayfa 40

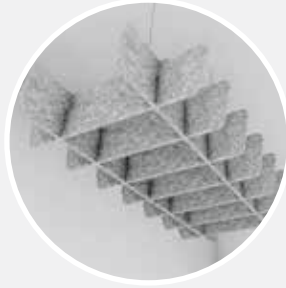

**BFL-P05**  
Sayfa 42

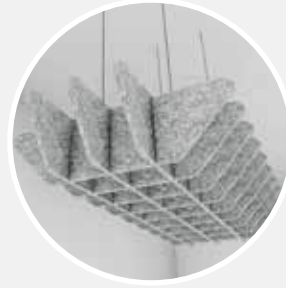

**BFL-P06**  
Sayfa 44



**BFL-P07**  
Sayfa 46

**Akustik Baffles - BFL-PO1**

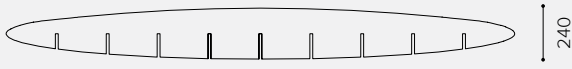

**Akustik Baffles - BFL-PO2**

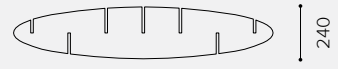

**Akustik Baffles - BFL-PO3**

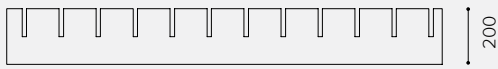

**Akustik Baffles - BFL-PO4**

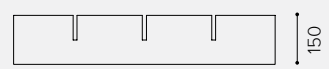

**Akustik Baffles - BFL-PO5**

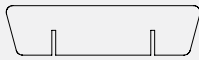
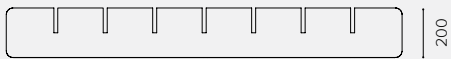

**Akustik Baffles - BFL-PO6**

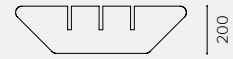

**Akustik Baffles - BFL-PO7**

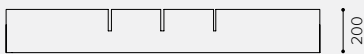

## FeltBi Panel Baffle | BFL-P01

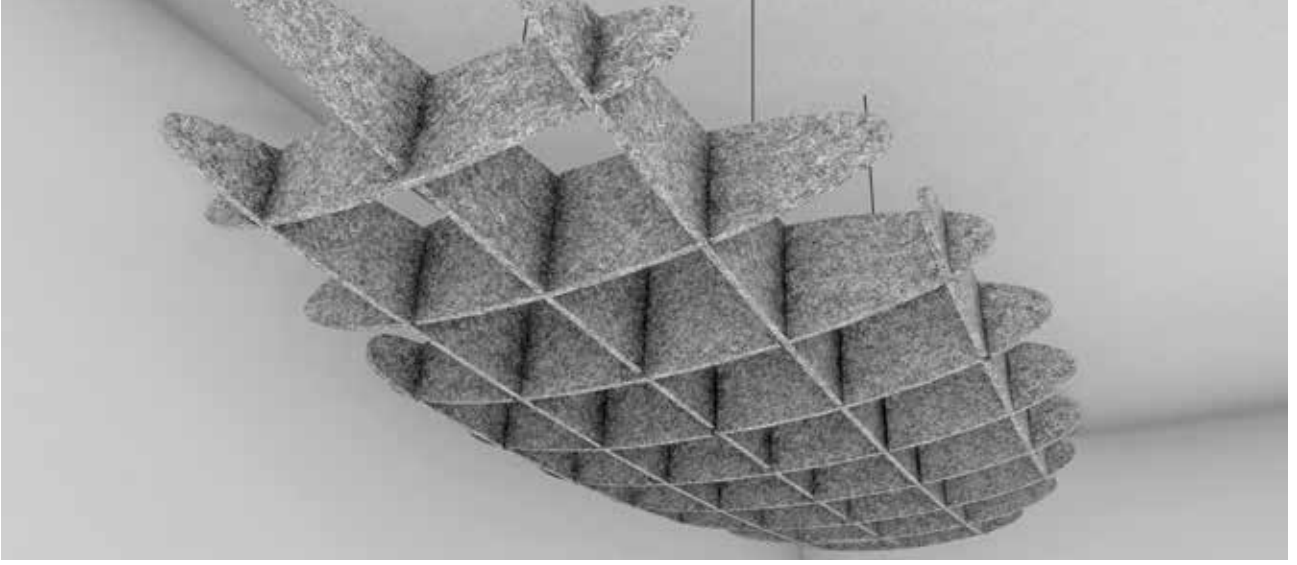

### Özellikler

<b>Malzeme:</b>	Polyester Elyaf Keçe
<b>Akustik özellikler:</b>	NRC: 0,40-0,90
<b>Yangın sınıfı:</b>	B-s1, d0
<b>Renk:</b>	FD Kartela (Bakınız sayfa 27), Klasik Kartela (Bakınız sayfa 30), KD Kartela (Bakınız sayfa 30)
<b>Kurulum:</b>	Çelik telli asansörlü tavan askı aparatı
<b>Bakım:</b>	Elektrik süpürgesi ile düşük devirde ağır baskı uygulanmadan dış yüzey temizliği yapılabilir. Nemli bir bezle hafifçe silinerek dış yüzey temizliği yapılabilir.

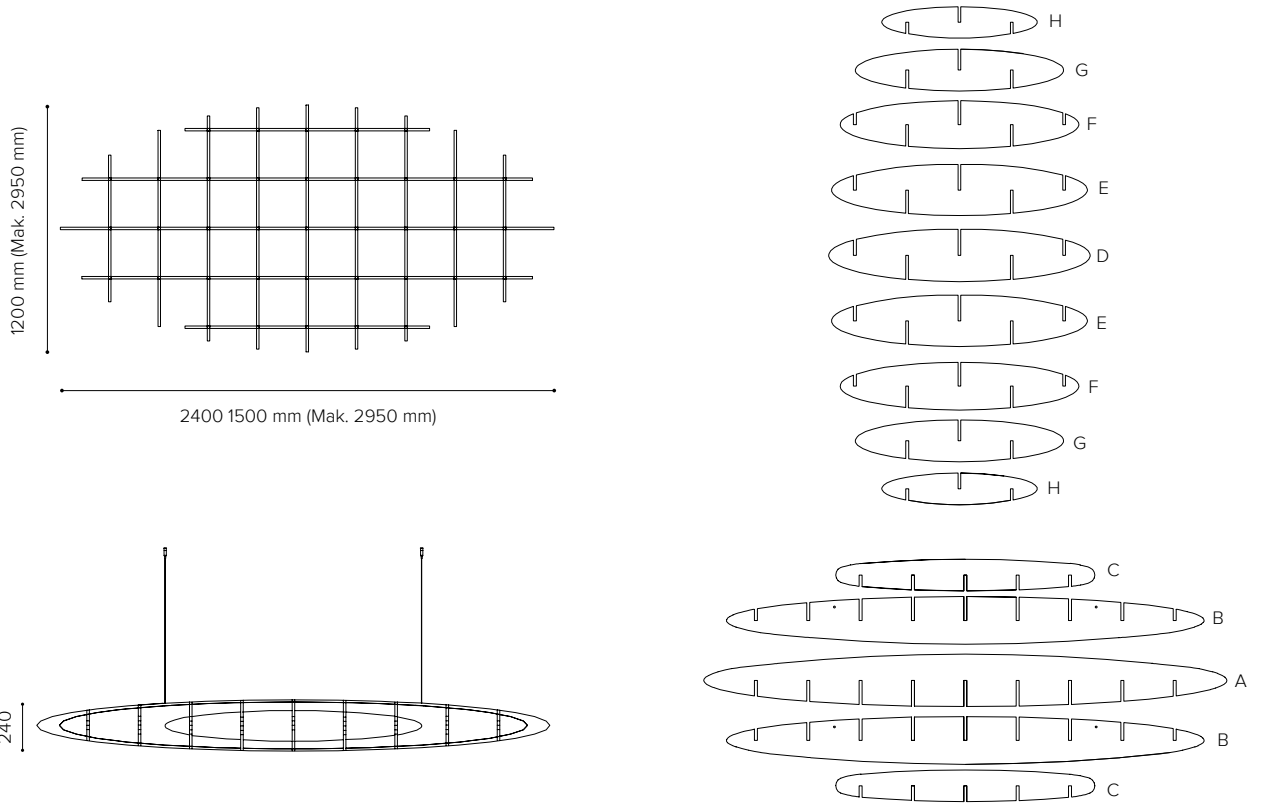

# FeltBi Panel Baffle | BFL-P02

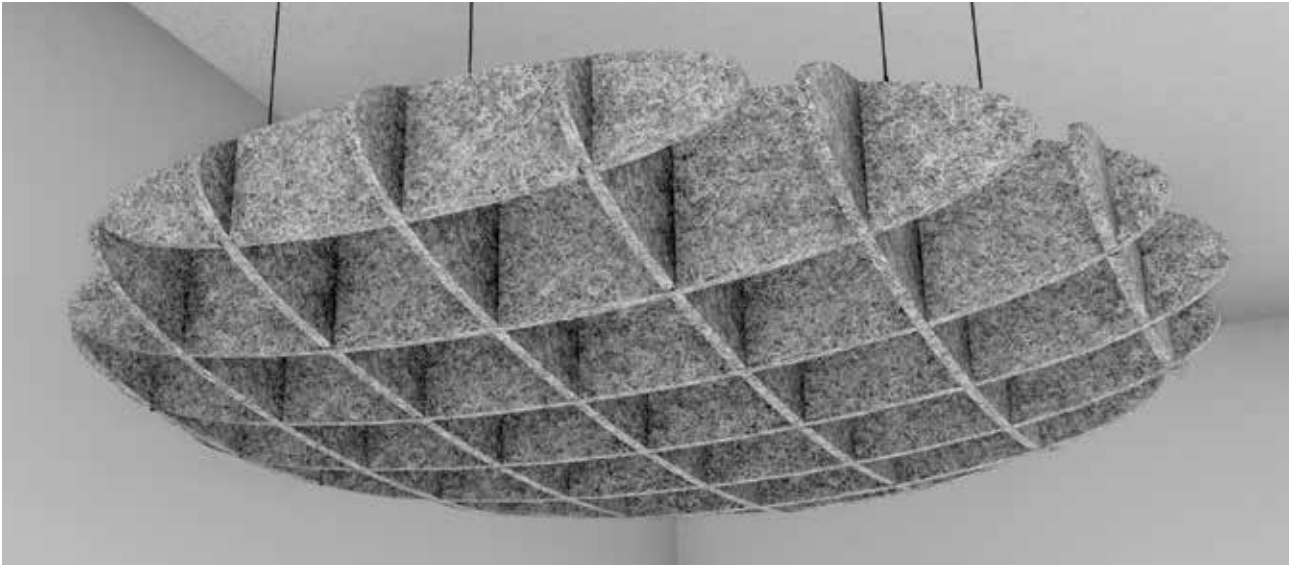

## Özellikler

<b>Malzeme:</b>	Polyester Elyaf Keçe
<b>Akustik özellikler:</b>	NRC: 0,40-0,90
<b>Yangın sınıfı:</b>	B-s1, d0
<b>Renk:</b>	FD Kartela (Bakınız sayfa 27), Klasik Kartela (Bakınız sayfa 30), KD Kartela (Bakınız sayfa 30)
<b>Kurulum:</b>	Çelik telli asansörlü tavan askı aparatı
<b>Bakım:</b>	Elektrik süpürgesi ile düşük devirde ağır baskı uygulanmadan dış yüzey temizliği yapılabilir. Nemli bir bezle hafifçe silinerek dış yüzey temizliği yapılabilir.

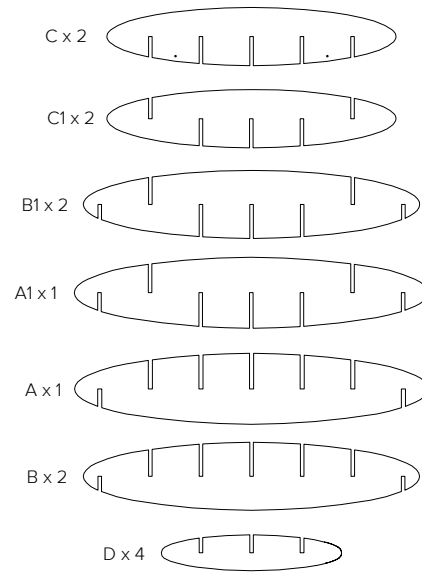
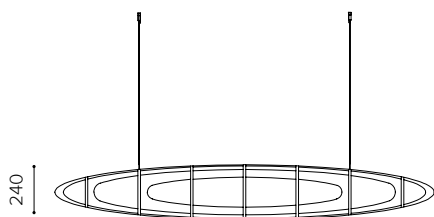
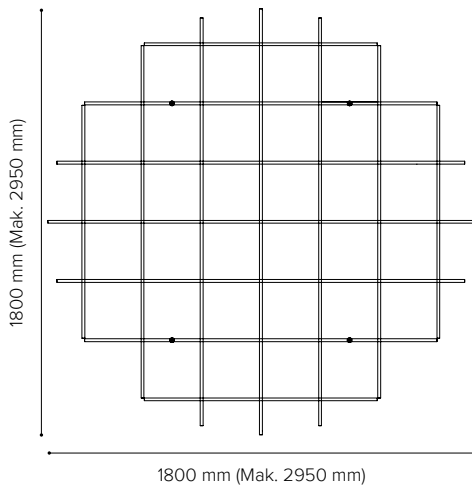

## FeltBi Panel Baffle | BFL-P03

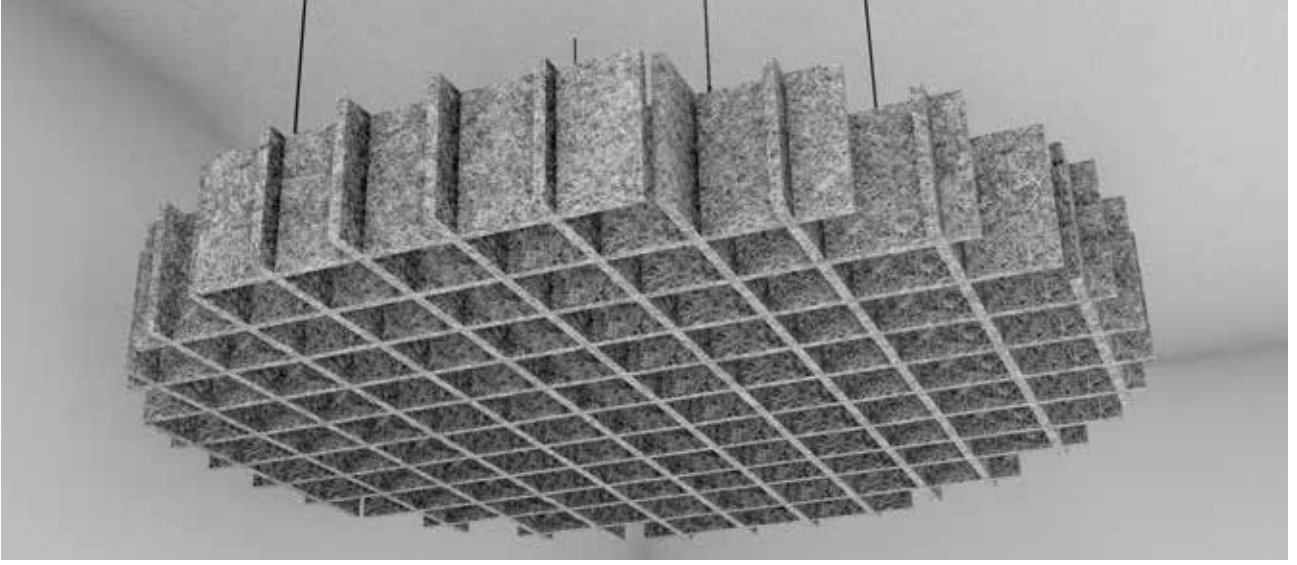

### Özellikler

<b>Malzeme:</b>	Polyester Elyaf Keçe
<b>Akustik özellikler:</b>	NRC: 0,40-0,90
<b>Yangın sınıfı:</b>	B-s1, d0
<b>Renk:</b>	FD Kartela (Bakınız sayfa 27), Klasik Kartela (Bakınız sayfa 30,) KD Kartela (Bakınız sayfa 30)
<b>Kurulum:</b>	Çelik telli asansörlü tavan askı aparatı
<b>Bakım:</b>	Elektrik süpürgesi ile düşük devirde ağır baskı uygulanmadan dış yüzey temizliği yapılabilir. Nemli bir bezle hafifçe silinerek dış yüzey temizliği yapılabilir.

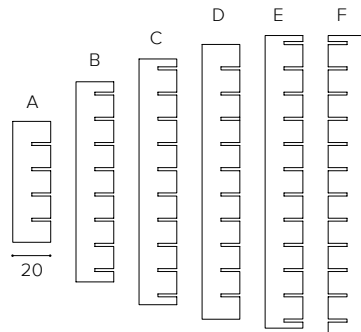
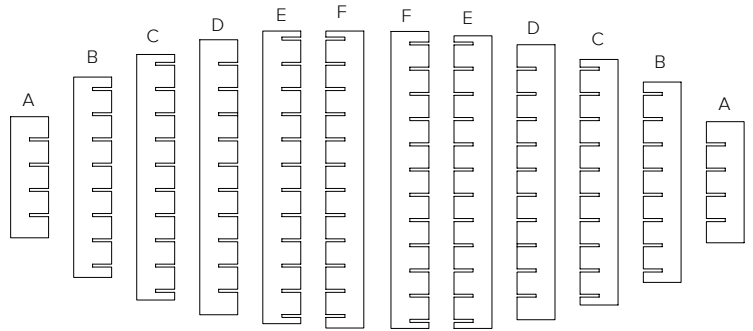
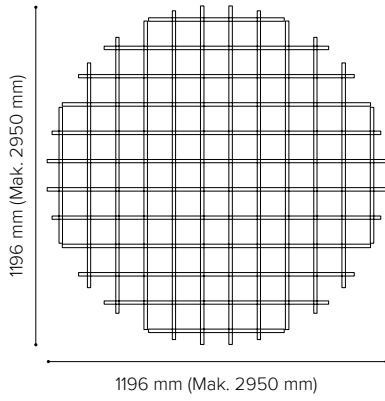

# FeltBi Panel Baffle | BFL-P04

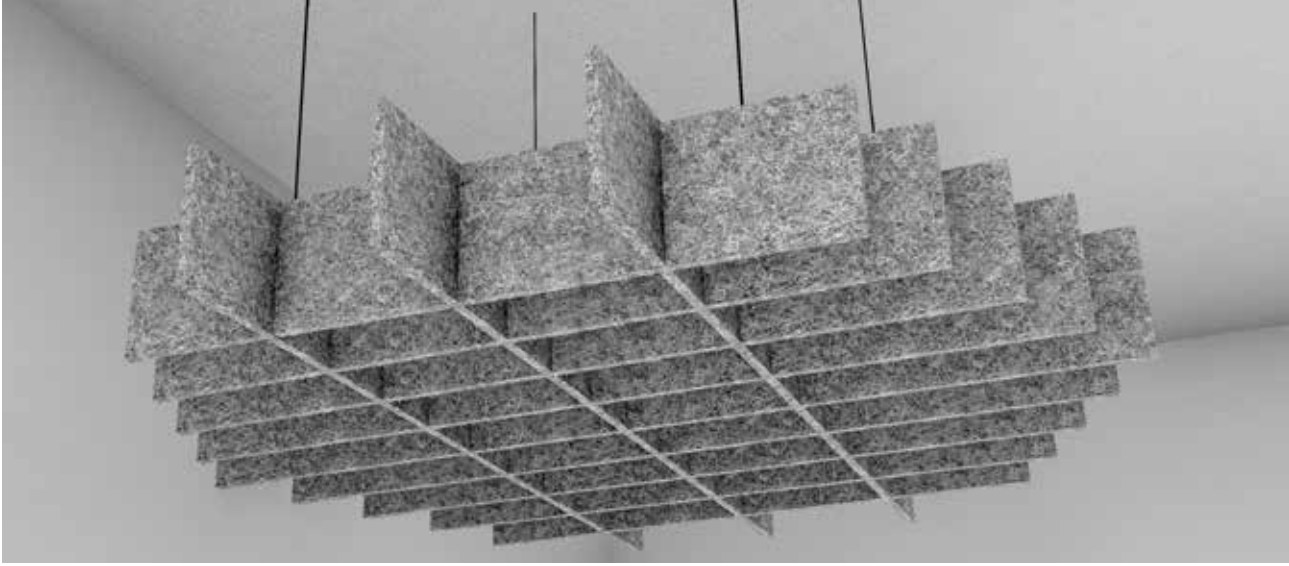

## Özellikler

<b>Malzeme:</b>	Polyester Elyaf Keçe
<b>Akustik özellikler:</b>	NRC: 0,40-0,90
<b>Yangın sınıfı:</b>	B-s1, d0
<b>Renk:</b>	FD Kartela (Bakınız sayfa 27), Klasik Kartela (Bakınız sayfa 30), KD Kartela (Bakınız sayfa 30)
<b>Kurulum:</b>	Çelik telli asansörlü tavan askı aparatı
<b>Bakım:</b>	Elektrik süpürgesi ile düşük devirde ağır baskı uygulanmadan dış yüzey temizliği yapılabilir. Nemli bir bezle hafifçe silinerek dış yüzey temizliği yapılabilir.

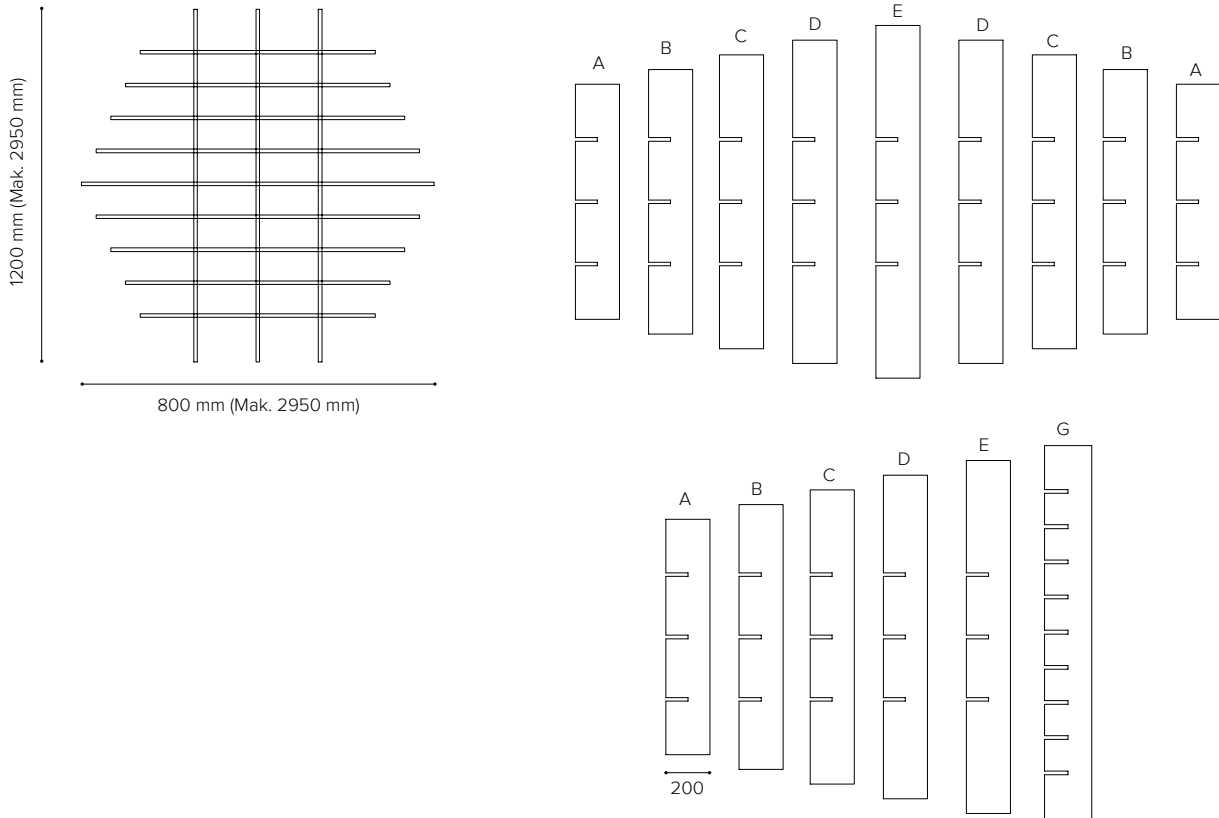

## FeltBi Panel Baffle | BFL-P05

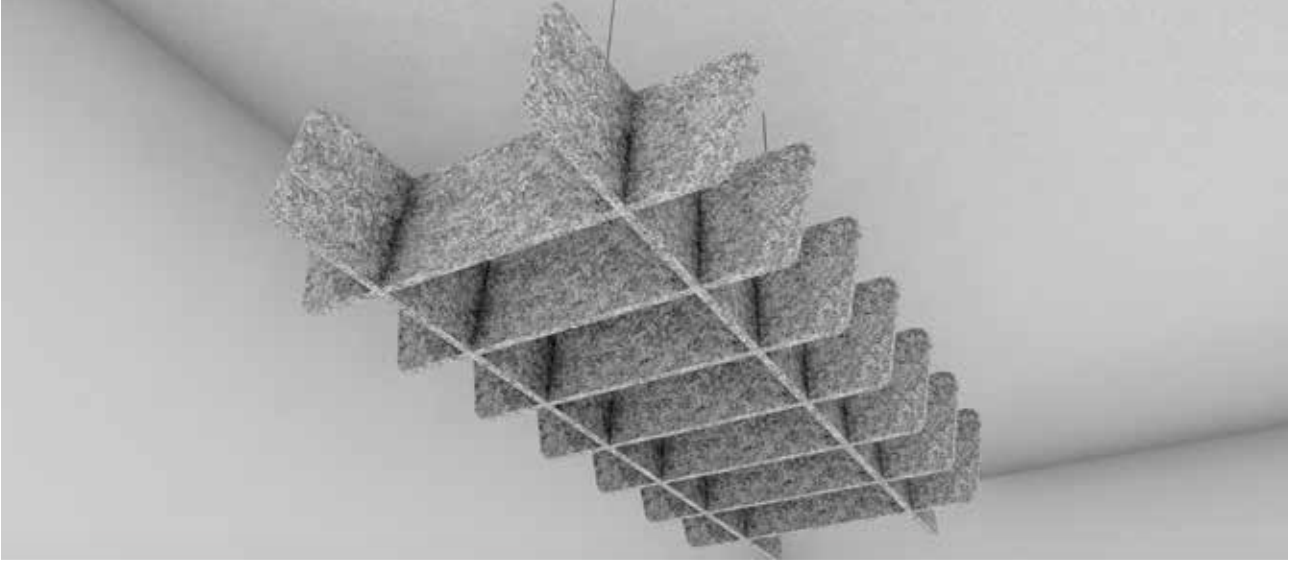

### Özellikler

<b>Malzeme:</b>	Polyester Elyaf Keçe
<b>Akustik özellikler:</b>	NRC: 0,40-0,90
<b>Yangın sınıfı:</b>	B-s1, d0
<b>Renk:</b>	FD Kartela (Bakınız sayfa 27), Klasik Kartela (Bakınız sayfa 30), KD Kartela (Bakınız sayfa 30)
<b>Kurulum:</b>	Çelik telli asansörlü tavan askı aparatı
<b>Bakım:</b>	Elektrik süpürgesi ile düşük devirde ağır baskı uygulanmadan dış yüzey temizliği yapılabilir. Nemli bir bezle hafifçe silinerek dış yüzey temizliği yapılabilir.

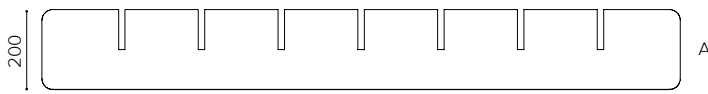
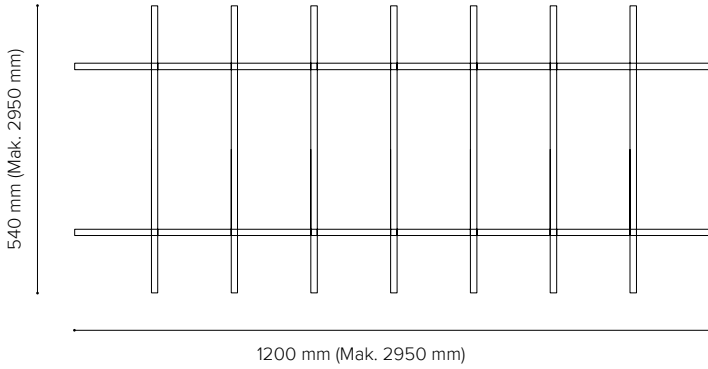

# FeltBi Panel Baffle | BFL-P06

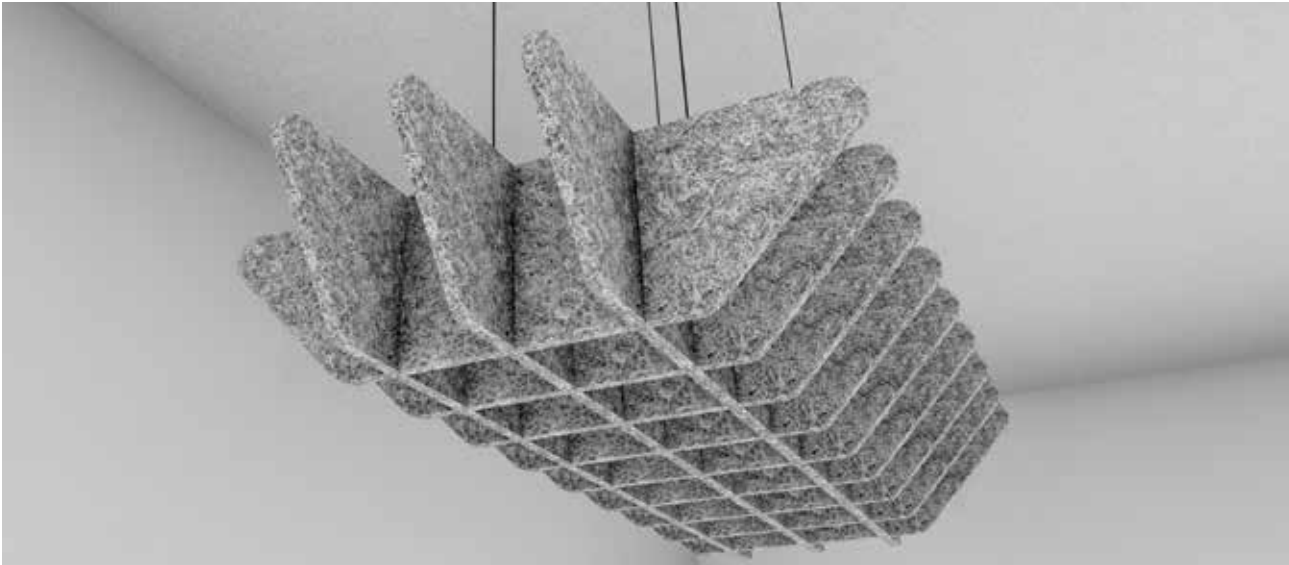

## Özellikler

<b>Malzeme:</b>	Polyester Elyaf Keçe
<b>Akustik özellikler:</b>	NRC: 0,40-0,90
<b>Yangın sınıfı:</b>	B-s1, d0
<b>Renk:</b>	FD Kartela (Bakınız sayfa 27), Klasik Kartela (Bakınız sayfa 30), KD Kartela (Bakınız sayfa 30)
<b>Kurulum:</b>	Çelik telli asansörlü tavan askı aparatı
<b>Bakım:</b>	Elektrik süpürgesi ile düşük devirde ağır baskı uygulanmadan dış yüzey temizliği yapılabilir. Nemli bir bezle hafifçe silinerek dış yüzey temizliği yapılabilir.

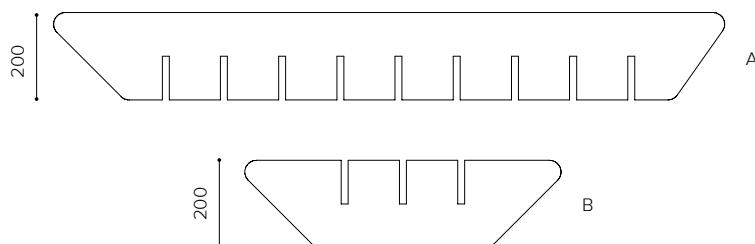
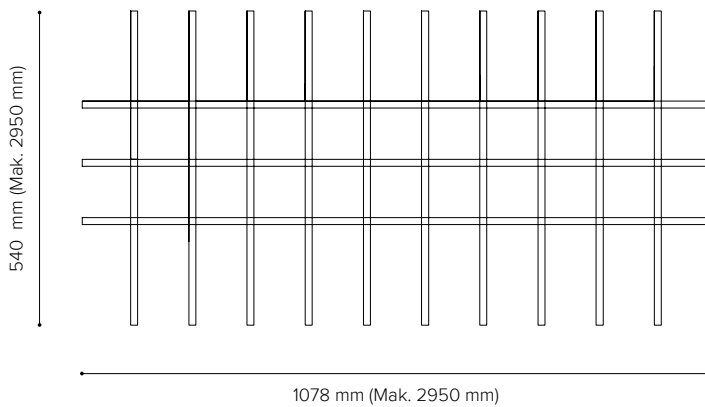

## FeltBi Panel Baffle | BFL-P07



### Özellikler

<b>Malzeme:</b>	Polyester Elyaf Keçe
<b>Akustik özellikler:</b>	NRC: 0,40-0,90
<b>Yangın sınıfı:</b>	B-s1, d0
<b>Renk:</b>	FD Kartela (Bakınız sayfa 27), Klasik Kartela (Bakınız sayfa 30), KD Kartela (Bakınız sayfa 30)
<b>Kurulum:</b>	Çelik telli asansörlü tavan askı aparatı
<b>Bakım:</b>	Elektrik süpürgesi ile düşük devirde ağır baskı uygulanmadan dış yüzey temizliği yapılabilir. Nemli bir bezle hafifçe silinerek dış yüzey temizliği yapılabilir.

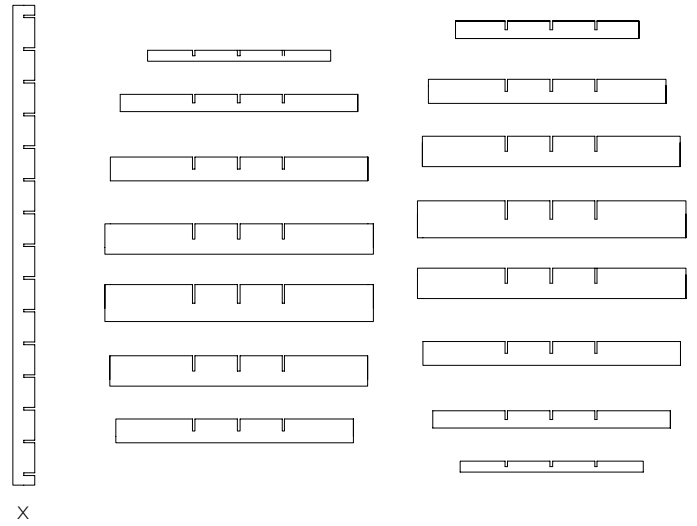
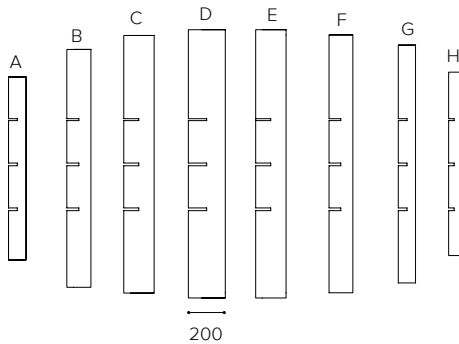
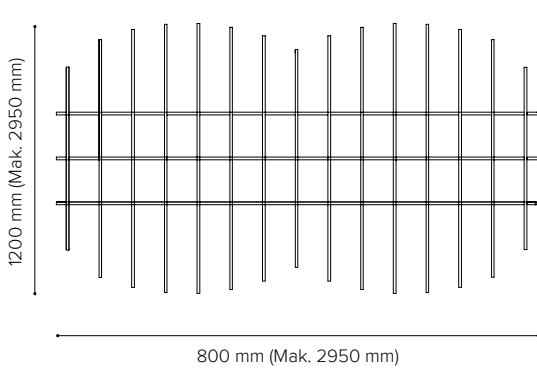

							
FD101	FD102	FD103	FD104	FD105	FD106	FD107	FD108
							
FD109	FD110	FD111	FD112	FD113	FD114	FD115	FD116
							
FD117	FD118	FD119	FD120	FD121	FD122	FD123	FD124
							
FD125	FD126	FD127	FD128	FD129	FD130	FD131	FD132
							
FD133	FD134	FD135	FD136	FD137	FD138	FD139	FD140
							
FD141	FD142	FD143	FD144	FD145	FD146	FD147	FD148
							
FD149	FD150	FD151	FD152	FD153	FD154	FD155	FD156
							
FD157	FD158	FD159	FD160	FD161	FD162	FD163	FD164
							
FD165	FD166	FD167	FD168	FD169	FD170	FD171	FD172

							
FD173	FD174	FD175	FD176	FD177	FD178	FD179	FD180
							
FD181	FD182	FD183	FD184	FD185	FD186	FD187	FD188
							
FD189	FD190	FD191	FD192	FD193	FD194	FD195	FD196
							
FD197	FD198	FD199	FD200	FD201	FD202	FD203	FD204
							
FD205	FD206	FD207	FD208	FD209	FD210	FD211	FD212
							
FD213	FD214	FD215	FD216	FD217	FD218	FD219	FD220
							
FD221	FD222	FD223	FD224	FD225	FD226	FD227	FD228
							
FD229	FD230	FD231	FD232	FD233	FD234	FD235	FD236
							
FD237	FD238	FD239	FD240	FD241	FD242	FD243	FD244

FD245	FD246	FD247	FD248	FD249	FD250	FD251	FD252
FD253	FD254	FD255	FD256	FD257	FD258	FD259	FD260
FD261	FD262	FD263	FD264	FD265	FD266	FD267	FD268
FD269	FD270	FD271	FD272	FD273	FD274	FD275	FD276
FD277	FD278	FD279	FD280	FD281	FD282	FD283	FD284
FD285	FD286	FD287	FD288	FD289	FD290	FD291	FD292
FD293	FD294	FD295	FD296	FD297	FD298	FD299	FD300
FD301	FD302	FD303	FD304	FD305	FD306	FD307	FD308
FD309	FD310	FD311	FD312	FD313	FD314	FD315	FD316

## KLASİK KEÇE RENKLERİ



## KD KEÇE RENKLERİ



## BF KARTELA KEÇE KUMAŞ RENKLERİ



[www.feltbiakustik.com](http://www.feltbiakustik.com)

Yeni ürün tasarımları ve çözümler için  
Feltbi'in web sitesini ziyaret edin.

feltbiakustik.com üzerinden projenizi  
planlayıp görselleştirebilir, fiyat teklifi  
alabilir ve siparişinizi verebilirsiniz.

Tüm çözümlerimiz ve tasarımlarımız  
hakkında güncel bilgilere sahip olmak için  
Feltbi Akustik'in sosyal medya ve dijital  
platformlarını ziyaret edin.

Bizi takip edin:



**Showroom / Merkez Ofis:**

Gülbahar Mahallesi Cemal Suriri Sokak  
Halim Meriç İş Merkezi  
No: 15-E D: 41 34120  
Mecidiyeköy, Şişli, İstanbul, Türkiye

**Üretim İstanbul:**

Bozkurt Mahallesi Dolapdere Caddesi  
No: 167 34375 Şişli, İstanbul, Türkiye

**Fabrika:**

Uşak Org. San. Bölgesi  
110. Cadde No: 300  
64000 Uşak, Türkiye

T: 444 30 64

info@feltbiacoustic.com

[www.feltbiakustik.com](http://www.feltbiakustik.com)

[www.feltbiacoustic.com](http://www.feltbiacoustic.com)

# FeltBi

Felt Building Insulation